

Treatment tables and Chairs



NAMRØL

Vera

Perfectly adapted
to your way of
working

Provide your
patients with
optimal comfort
and achieve the
best treatment
results.



Treatment Tables





Vera E2

Professional examination table with adjustable height

This two-section table demonstrates the perfect combination of design and functionality for your clinic. The adjustable headrest offers a versatile and practical solution for any type of general examination, in both reclined and extended positions.

Features

- Stable, safe and functional chassis.
- Motorised height regulation.
- Multifunction foot control with automatic zero position.
- Piston controlled adjustable headrest.
- High density foam upholstery.
- Steel structure in high gloss finish.
- Maximum lifting capacity: 220 kg.
- Wide range of accessories.
- Optimum designed base allowing ease of access from any angle.

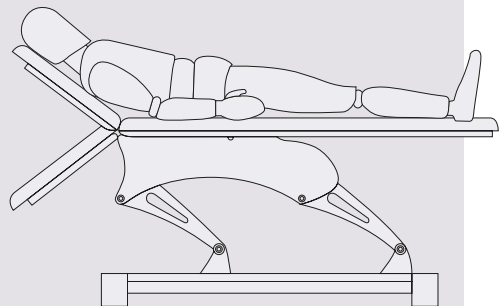
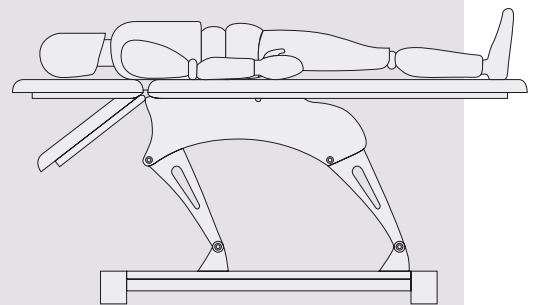



Vera EP2

Professional Examination table with adjustable height and Trendelenburg

This two-section table perfectly combines functionality and design. The adjustable headrest and mid-section offer a practical and versatile solution for any type of general examination in reclined, extended, and Trendelenburg positions.

Features

- Stable, safe and functional chassis.
- Motorised height regulation.
- Multifunction foot control with automatic zero position.
- Piston controlled adjustable headrest.
- Piston controlled adjustable mid section with Trendelenburg position.
- High density foam upholstery.
- Steel structure in high gloss finish.
- Maximum lifting capacity: 220 kg.
- Wide range of accessories.
- Optimum designed base allowing ease of access from any angle.

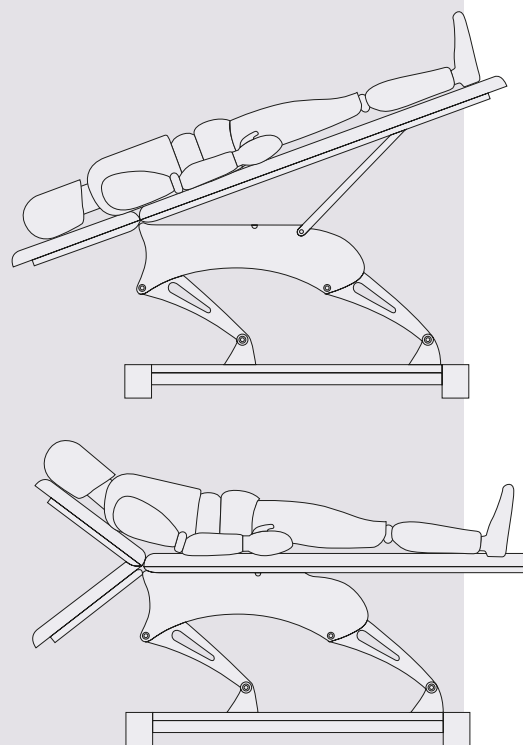



Vera E3

Professional examination table with adjustable height

Solid and functional 3-section table. Vera E3 is ideal for any type of examination in reclined, extended, or vertical positions.

Features

- Stable, safe and functional chassis.
- Motorised height regulation.
- Multifunction foot control with automatic zero position.
- Piston controlled adjustable headrest.
- Piston controlled adjustable leg support.
- High density foam upholstery.
- Steel structure in high gloss finish.
- Maximum lifting capacity: 220 kg.
- Wide range of accessories.
- Optimum designed base allowing ease of access from any angle.

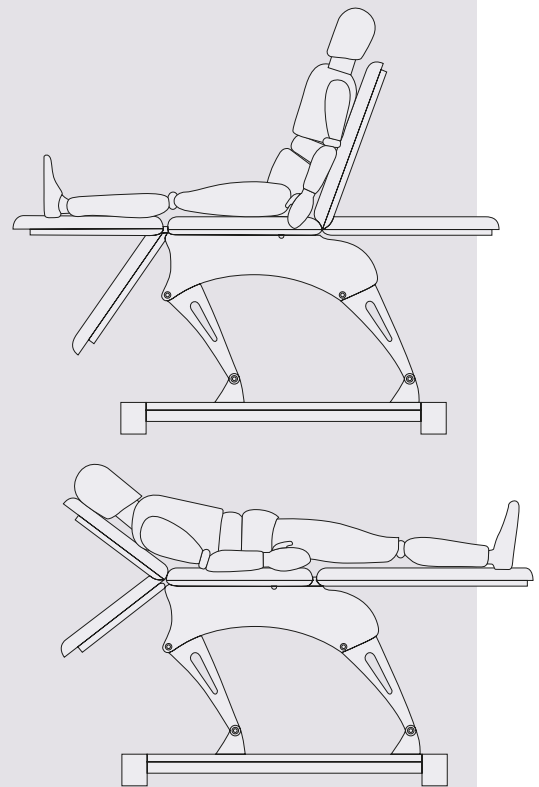



Vera M2

Professional examination table with adjustable height

Solid and functional 2-section table suitable for a wide range of manual therapy, massage, and diverse procedures in the examination of patients.

Features

- Stable, safe and functional chassis.
- Motorised height regulation.
- Multifunction foot control with automatic zero position.
- Piston controlled adjustable headrest.
- Ergonomic opening for the face in head support.
- High density foam upholstery.
- Steel structure in high gloss finish.
- Maximum lifting capacity: 220 kg.
- Wide range of accessories.
- Optimum designed base allowing ease of access from any angle.

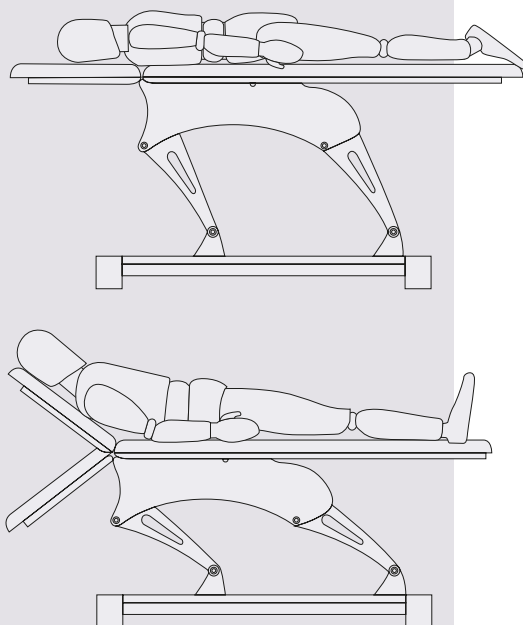



Vera M3

Professional examination table with adjustable height

Solid and functional 3-section table suitable for a wide range of techniques in manual therapy, massage, and diverse examination procedures.

Features

- Stable, safe and functional chassis.
- Motorised height regulation 53-95 cm.
- Multifunction foot control with automatic zero position.
- Piston controlled adjustable headrest.
- Ergonomic opening for the face in head support.
- Piston controlled adjustable leg support.
- High density foam upholstery.
- Steel structure in high gloss finish.
- Maximum lifting capacity: 220 kg.
- Wide range of accessories.
- Optimum designed base allowing ease of access from any angle.

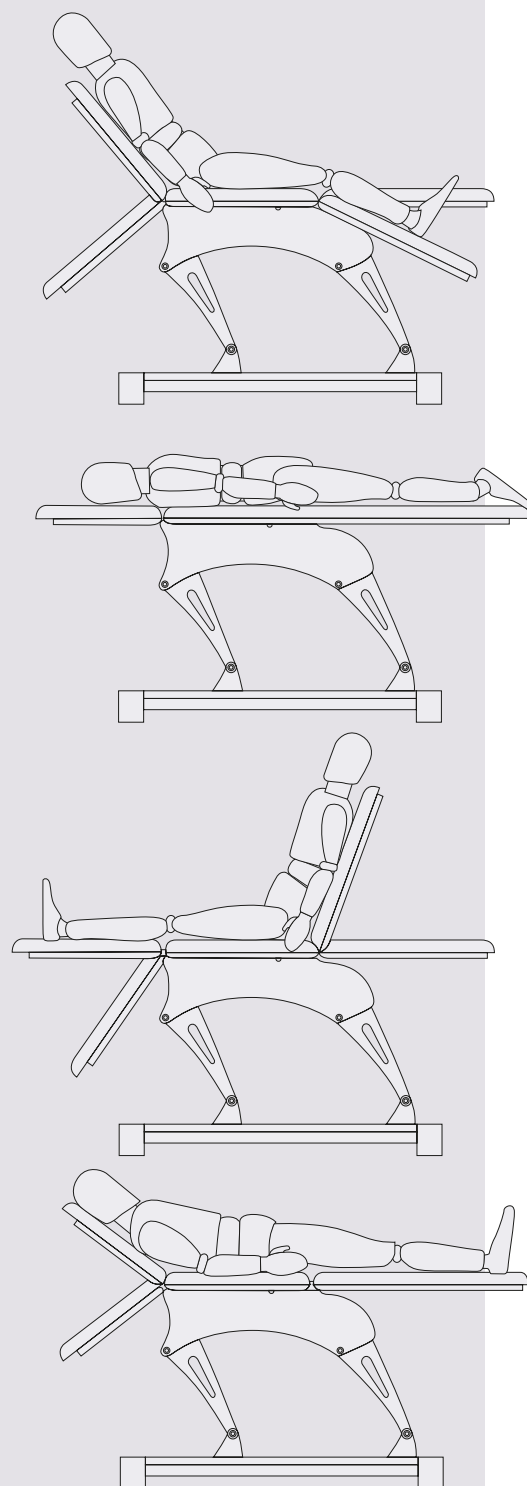



Vera M6

Professional massage treatment table with adjustable height

M6 is a fully equipped table designed for use in all types of massage and physiotherapy treatments. The retractable lateral supports allow professionals to get closer to the patient and apply greater force during treatments.

Features

- Stable, safe and functional chassis.
- Motorised height regulation.
- Multifunction foot control with automatic zero position.
- Piston controlled adjustable headrest.
- Headrest in 3 section with opening for face.
- Piston controlled adjustable leg support.
- Removable arm rests.
- High density foam upholstery.
- Steel structure in high gloss finish.
- Maximum lifting capacity: 220 kg.
- Wide range of accessories.
- Optimum designed base allowing ease of access from any angle.

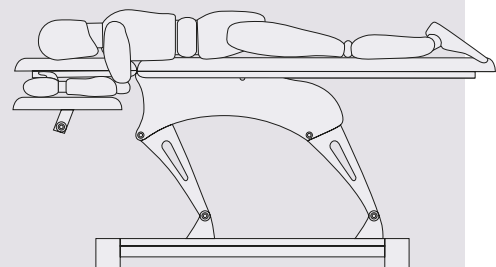
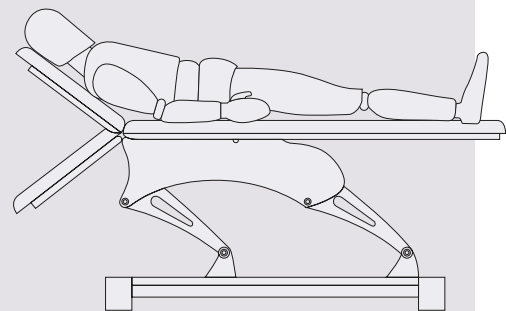
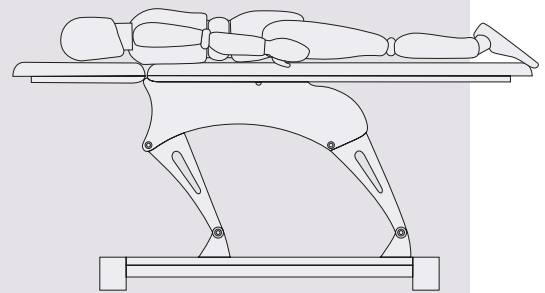



Vera T3

Professional massage treatment table with adjustable height

This 3-part treatment table combines functionality and design for your clinic. The adjustable headrest and leg support provide a versatile and practical solution for any type of therapy in a reclining, vertical, or sitting position.

Features

- Stable, safe and functional chassis.
- Motorised height regulation.
- Multifunction foot control with automatic zero position.
- Piston controlled adjustable headrest.
- Ergonomic, elongated opening for the face in head support
- Piston controlled leg support
- High density foam upholstery.
- Steel structure in high gloss finish.
- Maximum lifting capacity: 220 kg.
- Wide range of accessories.
- Optimum designed base allowing ease of access from any angle.

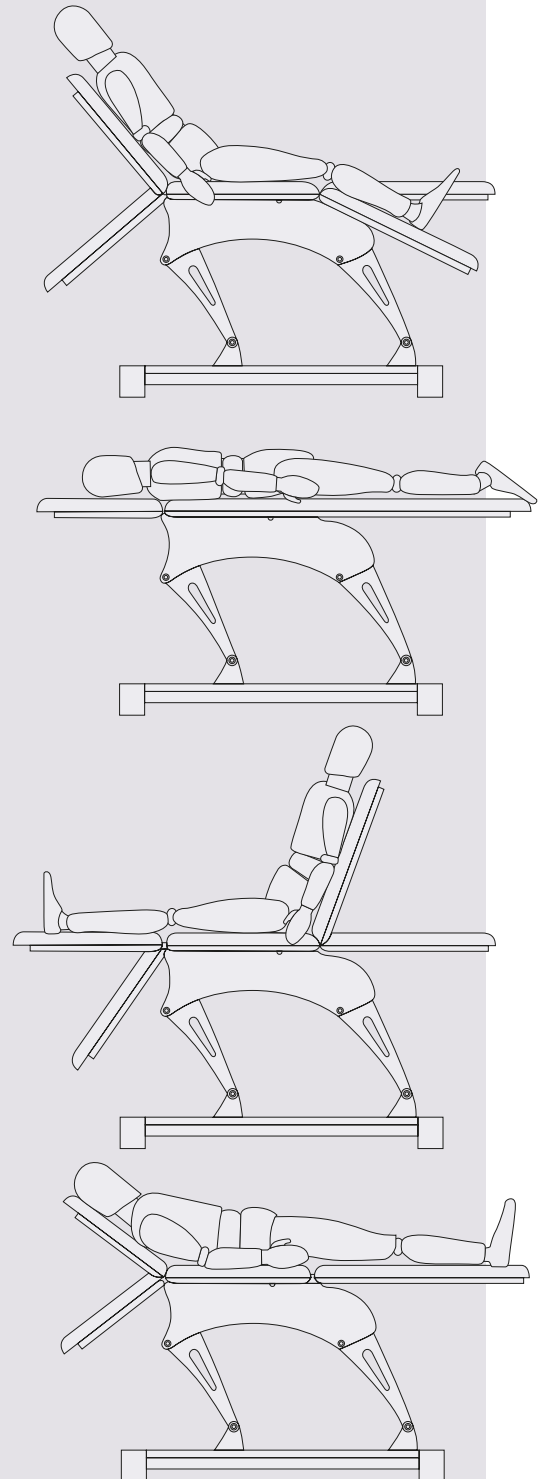



Vera TP3

Height adjustable treatment table with Trendelenburg

Sturdy and functional therapy and treatment table in 3-sections. Suitable for different positions: sitting, supine, lumbar manipulation techniques, and Trendelenburg position

Features

- Stable, safe and functional chassis.
- Motorised height regulation.
- Multifunction foot control with automatic zero position.
- Piston controlled adjustable headrest.
- Elongated opening for face in head rest.
- Piston controlled adjustable leg support.
- Piston controlled adjustable middle section with Trendelenburg position.
- High density foam upholstery.
- Steel structure in high gloss finish.
- Maximum lifting capacity: 220 kg.
- Wide range of accessories.
- Optimum designed base allowing ease of access from any angle.

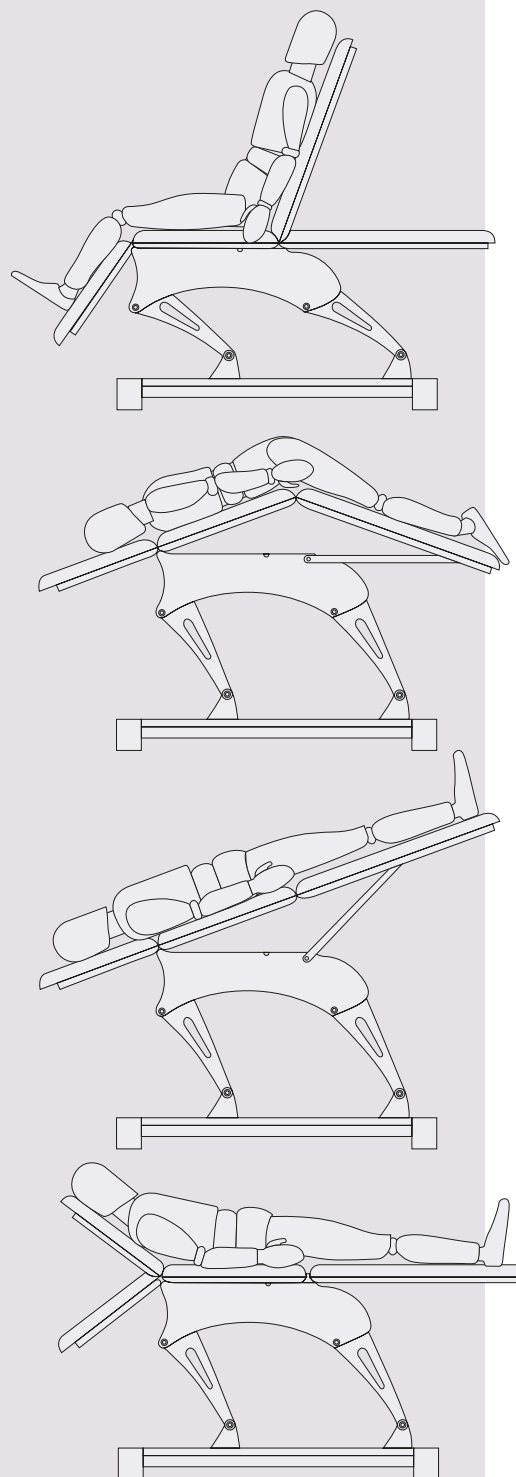



Vera TP5

Height adjustable treatment table with Trendelenburg

TP5 is a treatment table designed specifically for therapists who work with spinal cord treatments and other specialized fields.

Features

- Stable, safe and functional chassis.
- Motorised height regulation.
- Multifunction foot control with automatic zero position.
- Piston controlled adjustable headrest.
- 3 part head rest with elongated opening for face.
- Piston controlled adjustable leg support.
- Piston controlled adjustable middle section with Trendelenburg position.
- High density foam upholstery.
- Steel structure in high gloss finish.
- Maximum lifting capacity: 220 kg.
- Wide range of accessories.
- Optimum designed base allowing ease of access from any angle.

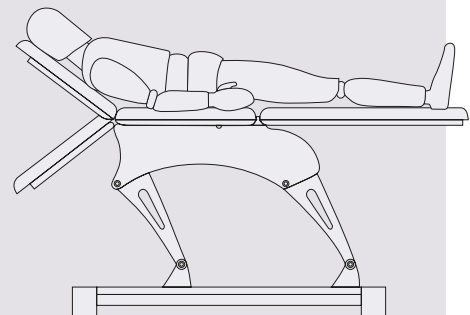
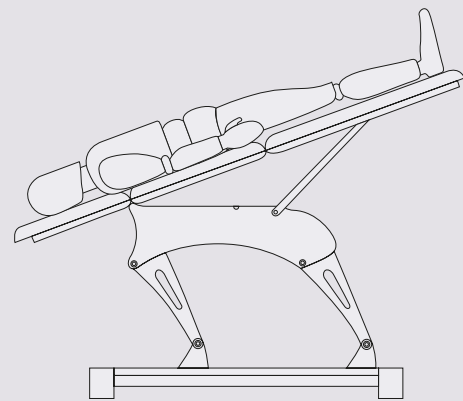
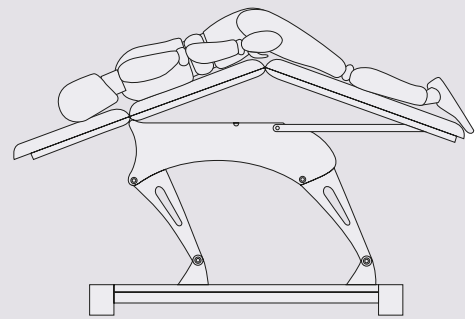
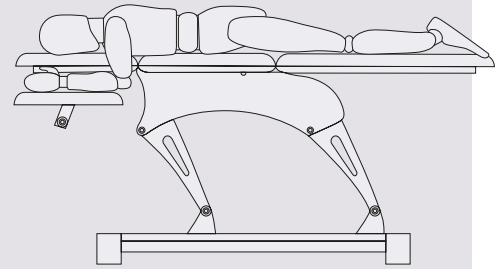

Ergonomics and unlimited comfort

The adjustable movements ensure ergonomic work in any treatment position



| | E2 | EP2 | E3 | M2 |
|--------------------------|---------------|---------------|---------------|---------------|
| Technical details | | | | |
| Number of motors | 1 | 1 | 1 | 1 |
| Power connection | 100-240 VAC | 100-240 VAC | 100-240 VAC | 100-240 VAC |
| Frecuency | 50 / 60 Hz | 50 / 60 Hz | 50 / 60 Hz | 50 / 60 Hz |
| Watt | 150 W | 150 W | 150 W | 150 W |
| Standby power | Approx. 0.5 W | Approx. 0.5 W | Approx. 0.5 W | Approx. 0.5 W |
| Home position button | ✓ | ✓ | ✓ | ✓ |
| Sections | 2 | 2 | 3 | 2 |
| Warranty | 5 years | 5 years | 5 years | 5 years |
| Colors | 18 | 18 | 18 | 18 |

Movements

| | | | | |
|----------------------|------------|------------|------------|------------|
| Height adjustment | Electrical | Electrical | Electrical | Electrical |
| Head rest adjustment | Gas spring | Gas spring | Gas spring | Gas spring |
| Leg rest adjustment | X | X | Gas spring | X |
| Trendelenburg | X | Gas spring | X | X |
| Armrest | X | X | X | X |

Weights

| | | | | |
|------------------|--------|--------|--------|--------|
| Lifting capacity | 220 Kg | 220 Kg | 220 Kg | 220 Kg |
| Table Weight | 77 Kg. | 78 Kg. | 79 Kg. | 76 Kg. |

What's your ideal model?



M3

M6

T3

TP3

TP5

| | | | | |
|---------------|---------------|---------------|---------------|---------------|
| 1 | 1 | 1 | 1 | 1 |
| 100-240 VAC | 100-240 VAC | 100-240 VAC | 100-240 VAC | 100-240 VAC |
| 50 / 60 Hz | 50 / 60 Hz | 50 / 60 Hz | 50 / 60 Hz | 50 / 60 Hz |
| 150 W | 150 W | 150 W | 150 W | 150 W |
| Approx. 0.5 W | Approx. 0.5 W | Approx. 0.5 W | Approx. 0.5 W | Approx. 0.5 W |
| ✓ | ✓ | ✓ | ✓ | ✓ |
| 3 | 6 | 3 | 3 | 5 |
| 5 years | 5 years | 5 years | 5 years | 5 years |
| 18 | 18 | 18 | 18 | 18 |

| | | | | |
|------------|------------|------------|------------|------------|
| Electrical | Electrical | Electrical | Electrical | Electrical |
| Gas spring | Gas spring | Gas spring | Gas spring | Gas spring |
| Gas spring | X | Gas spring | Gas spring | Gas spring |
| X | X | X | Gas spring | Gas spring |
| X | Adjustable | X | X | Adjustable |

| | | | | |
|--------|--------|--------|--------|--------|
| 220 Kg | 220 Kg | 220 Kg | 220 Kg | 220 Kg |
| 78 Kg. | 80 Kg. | 79 Kg. | 79Kg. | 82 Kg. |

Vera Dimensions and Measures



E2

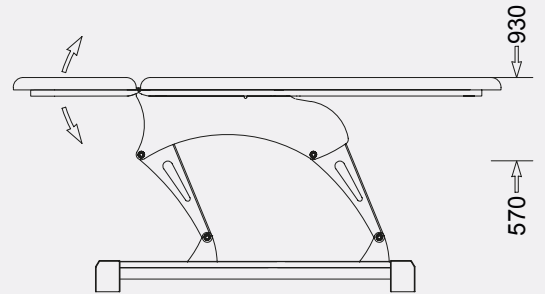
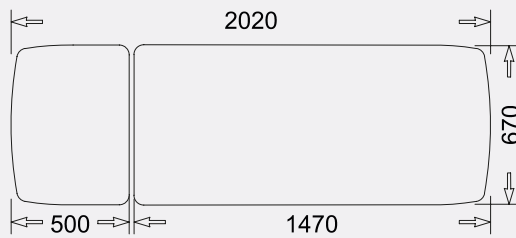

EP2

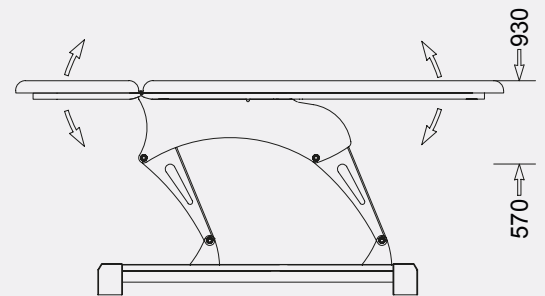
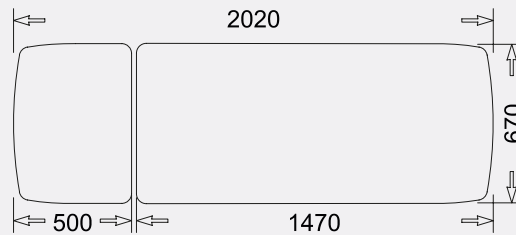

E3

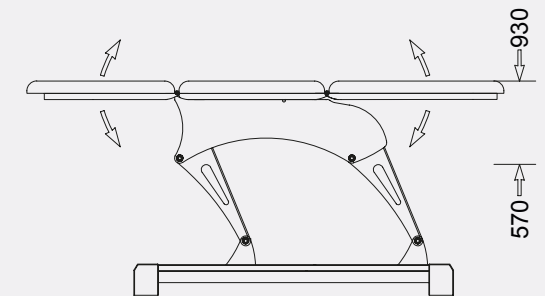
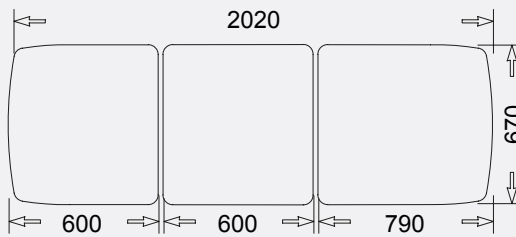

M2

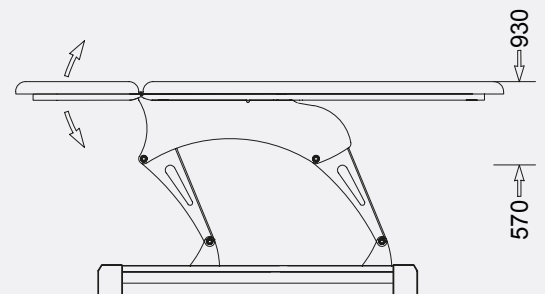
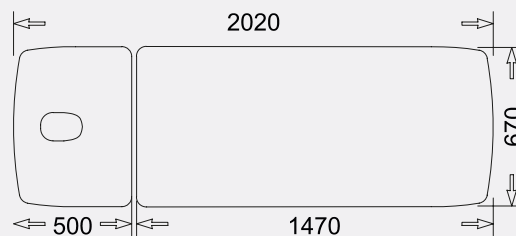



M3

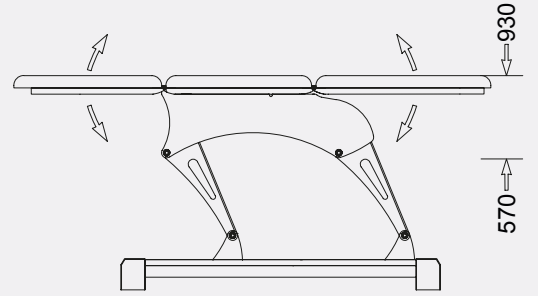
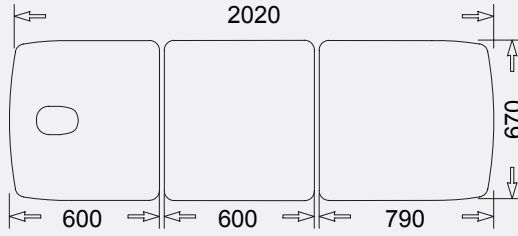

M6

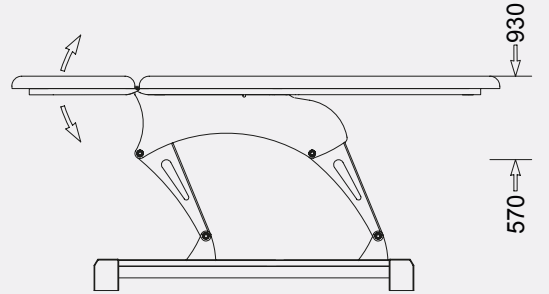
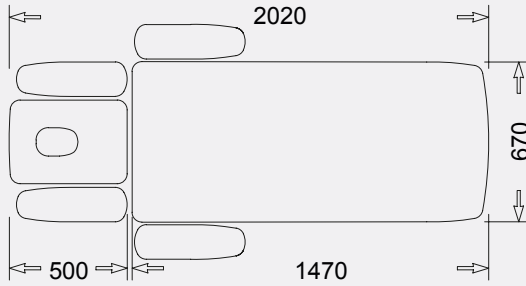

T3

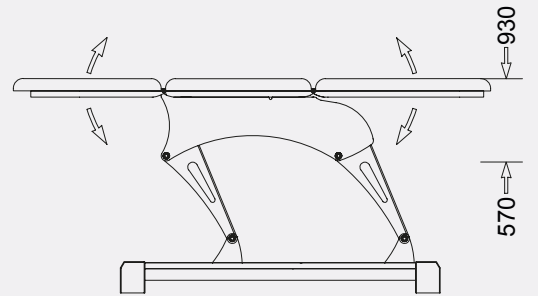
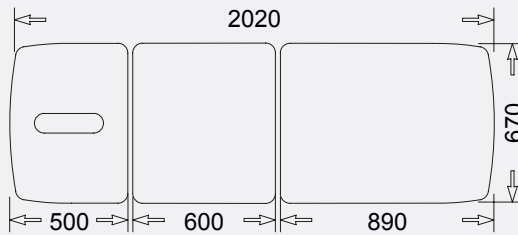

TP3

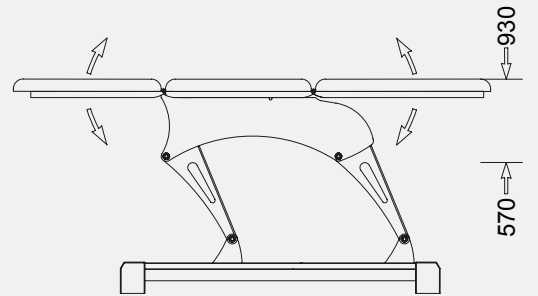
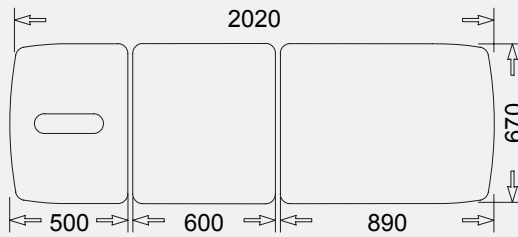

TP5

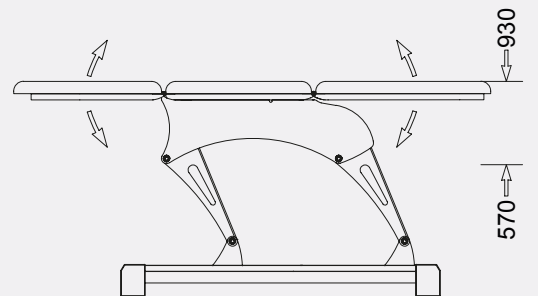
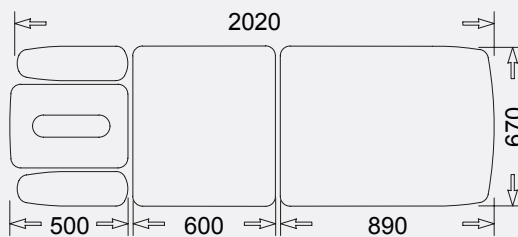



skai®

Ideal cover for intensive use

High quality skai® material with fine calf leather grain and subdued matte-gloss-effect.
 Disinfectant resistant.
 Fulfills medical standard DIN EN ISO 10993-5+10.
 Long-lasting.
 Easy to clean.
 Tear resistant.
 Blood- and urine resistant .

Stability and

Sturdy, reinforced steel provides dynamic stability to any sudden weight change by either the patient or during treatment.



LINAK® 
 WE IMPROVE YOUR LIFE

High Performance and Control

Low-noise durable and powerful actuators, with high speed/high performance and mechanical endstop for first failure safety. This makes it the right choice for the future.

and durability

chassis
 ability that reacts
 changes caused
 practitioner



STABILUS Variable Positioning

A special piston / valve system, which separates the two pressure chambers in the spring, allows effortless movement and locking.

Details make the difference

Passion for Quality Made in Spain.

It's just a small thing that most people wouldn't notice, but it's a detail worth noting in the quest for outstanding quality and durability.



Highlights



Confort

Combining both maximum comfort and support, this treatment table features extra thick foam finished in high-quality vinyl upholstery, providing smooth, silent, and reliable electrical movements. The practical width of the upholstery is 100%.



Hygiene

All exposed parts are easily cleaned, and being upholstered in SKAI® allows for easy cleaning and disinfection.



Safety

The sturdy and reinforced steel chassis offers dynamic stability that responds to sudden weight changes caused by the patient or the practitioner during treatment. The self-lubricating, cushioned bearings not only enhance the durability of the table but also provide a smooth operation.



Accessibility

The H-shaped frame design provides maximum accessibility during treatments, with a 53 cm floor-to-table distance for easy patient access.

Vera Optional Accessories



Autoblock

Mechanized centralized locking system with 4 double rotation castors allows for easy maneuverability over short distances with 50mm wheels.



Hand Switch

Sensitive and very easy to use control (Optional).



Face hole plug

Provides support and comfort when the treatment requires.



Paper Roll Holder

Ergonomic paper support, easy to fix paper (maximum length 50cm - Ø 12,5 cm)



New generation seats, a fusion of contemporary design with attention to essential ergonomic features. A properly supported back for the professional whilst carrying out his duties.

NAMROL

Stools

Ergonomic for ideal posture.

It's just a small thing that most people wouldn't notice, but it's a detail worth noting in the quest for outstanding quality and durability.



COSMOS

Anatomic stool with backrest, upholstered in SKAY, seamless easy to clean with piston controlled height regulation. Soft double wheels mounted on a chrome finish with 5 support points. Colors can be matched to the range of colors for the treatment beds.



MONZA

Anatomic stool with half moon back rest, upholstered in SKAY, seamless easy to clean with piston controlled height regulation. Soft, double castors mounted on chrome finish, with 5 points of support. Colors can be matched to the range of colors for the treatment beds



CORSA

Ergonomically designed stool to maintain proper posture, upholstered in SKAY seamless, easy to clean with piston controlled height regulation. Soft double wheels mounted on a chrome finish with 5 support points. Colors can be matched to the range of colors for the treatment beds.



CORSA - V

Very healthy, incredibly comfortable "Saddle seat" with backrest. It is possible to adjust the height of the stool through gas spring.



CORSA - L

Very healthy, incredibly comfortable "Saddle seat" with backrest. It is possible to adjust the height of the stool through gas spring.



MONZA - T

It is possible to adjust the height of the stool through gas spring.



Exclusive personality

High-quality skai® material with fine calf leather grain and subdued matte-gloss-effect. The very extensive and trend-orientated color spectrum enables many combinations.



| | | |
|--|--|--|
| | Long-lasting | ✓ |
| | Tear resistant | ✓ |
| | Easy to clean | ✓ |
| | Abrasion resistance | > 50.000 |
| | Skin irritation and sensitivity ISO 10993-10 | No reaction |
| | Cytotoxicity ISO 10993-5 | Complies |
| | UV resistance | ✓ |
| | Composition | 90% PVC-compound 10% knitted fabric |
| | Made in | Germany |



The colour samples are indicative and not intended as an exact replica of the actual colour of the product.
The products are subject to modifications and improvements without previous notice.





UPHOLSTERY

Our senses enable us to appreciate quality and aesthetics. Our eyes register every nuanced colour hue. Our hands explore surfaces and textures.

It is this uncompromising perfection which turns Namrol upholstery into an experience for all the senses.



NAMRØL

C. Progrés, 24-26

08850 Gavà · Barcelona · Spain

www.namrol.com

export@namrol.com

Tel. : +34 93 637 47 47

Distributed by

BIO CURE
MEDICAL PRODUCTS

Επιδαύρου 2 - Εύσμος
56224 Θεσσαλονίκη
T: 2316.070.056
E: info@biocure.gr
W: www.biocure.gr